

RIJRICHTING

VAN PREV poort 1-2

Ø8x1

1 PEM

1-1

Ø8x1

Ø12x1,5

TEST X

BALGTANK
INHOUDE: MIN. 20 L./AS

ISD 7638
449.173.120.0

<D>

WEGSENSOR
441.050.100.0

449.723.***.0

449.811.050.0

449.445.***.0

2

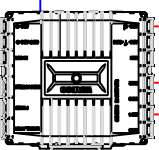

449.723.***.0

<C>

<optioneel>

<optioneel>

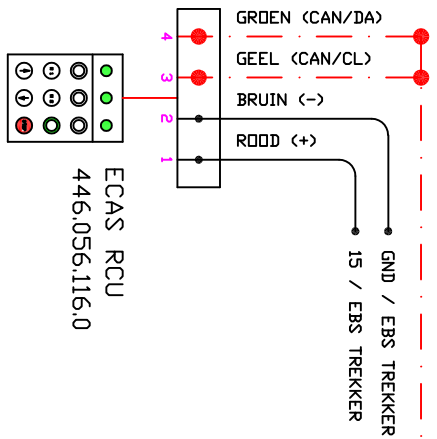

SMART BOARD
446.192.210.0

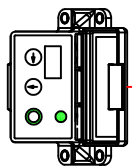

449.926.234.0(Y-kabel)

449.911.***.0

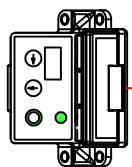

AS 1

(AS 2)

(AS 3)

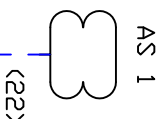

<22>

<22>

TEST X

<24>

TEST X

<24>

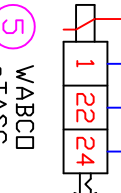
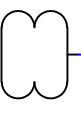

5 WABCD
eTASC

Ø8x1

LEIDINGEN RND. 8x1 MM

Ø12x1,5

LEIDINGEN RND. 12x1,5 MM

5 1 eTASC 463.090.502.0 WABCD

4 1 eTASC 463.090.502.0 WABCD

3 1 EBS-E MOD. 480.102.0***.0 WABCD

2 1 P E M 461.513.***.0 WABCD

1 1 P E M 461.513.***.0 WABCD

POS AAN BENAMING PROFIEL LENGTE MATERIAAL

NIR TAL

LUCHTVEERSCHEMA

ECAS / 1 WS / eTASC

B D.R.A.C.O.

FABRIEK VAN WEGTRANSPOORTMIDDELEN
ZADELMAKERSSTRAAT 9
8601 WH SNEEK
TEL. 0516-415615
FAX 0516-417867

SCHAAL : 1:1

GET : A BERGSMA

DATUM : 20-03-2020

GECONT :

OPDRACHTGEVER

TEKENINGNUMMER

0,20.108.187 PEM

DEZE TEKENING IS EN IN LIFT EIGENDOM VAN B.V. D.R.A.C.O. FABRIEK VAN WEGTRANSPOORTMIDDELEN ZADELMAKERSSTRAAT 9 TE SNEEK EN MAG ZONDER HAAR SCHRIFTTELIJKE TOESTEMMING NOCH IN HAAR GEHEEL NOCH TEN DELE GEMKOPED OF TER INZAGE WORDEN GEGEVEN